

# 2017

## Advertising Media Kit <sup>+</sup>

Editorial Calendar

Bright marketing ideas, brilliant promotional opportunities in print and online.

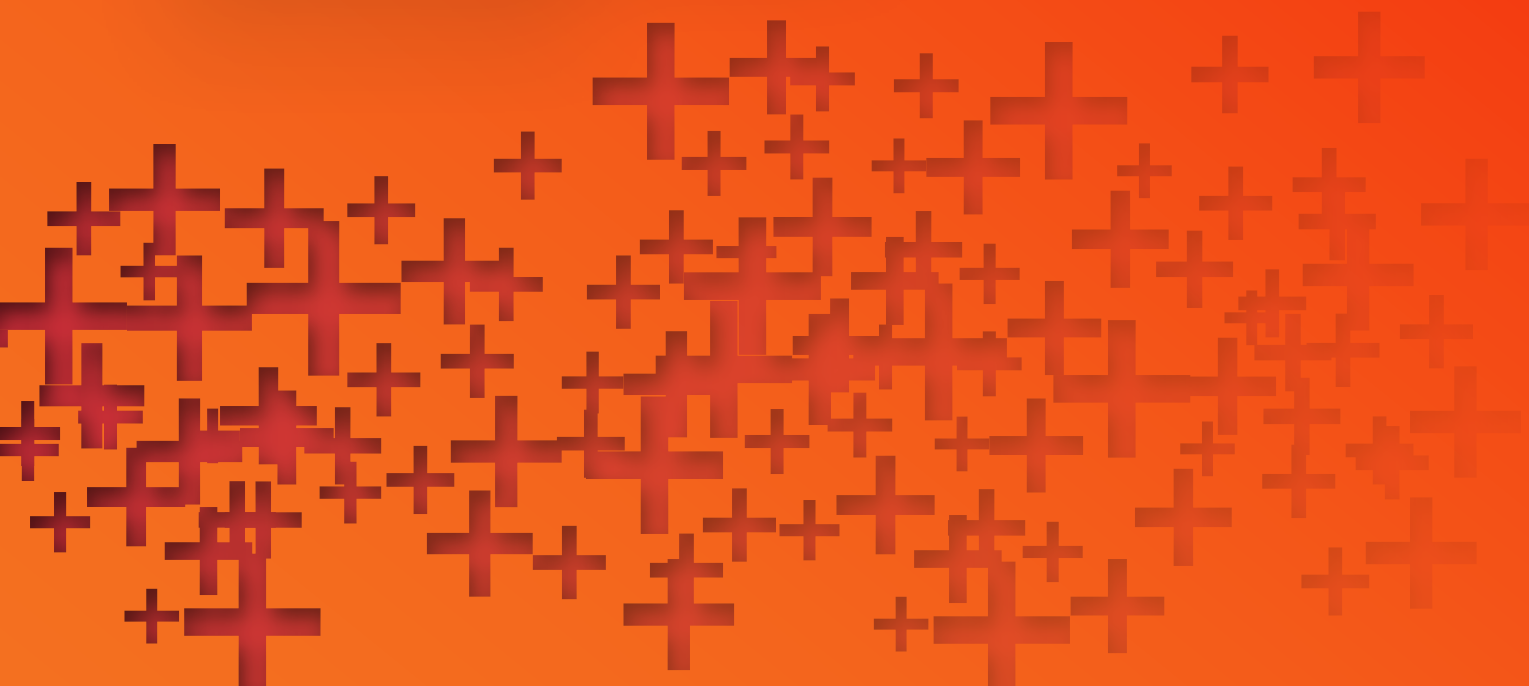

 mall media INC

Visit us at: [www.mallmedia.net](http://www.mallmedia.net)

# Contents

Are you an Industry Insider? ... pg.3

Tactics Magazine ... pg.4-9

- Editorial Calendar for 2017 Quarterly Special Print Editions
- Print Ad Specifications
- Inserts & Flyers
- Online Ad Specifications
  - Tactics Online
  - Shopping Center Weekly
- Sponsored Features
- Terms and Conditions

Marketing Trendz ... pg.10-12

- Editorial & Advertising Contacts
- Print Ad Specifications

Mall Media Key Contacts ... pg.14

- Editorial, Subscriptions & Advertising



Mall Media Inc. has been informing, connecting and supplying shopping center professionals since 1980. A member and media partner of ICSC, it operates Mall Media Kids, the world's leading supplier of personalized seasonal giveaways, and also publishes *Tactics Magazine*, *Marketing Trendz* and *Shopping Center Weekly*, trusted global retail marketing and management trade publications. Access them all from the Mall Media Hub.

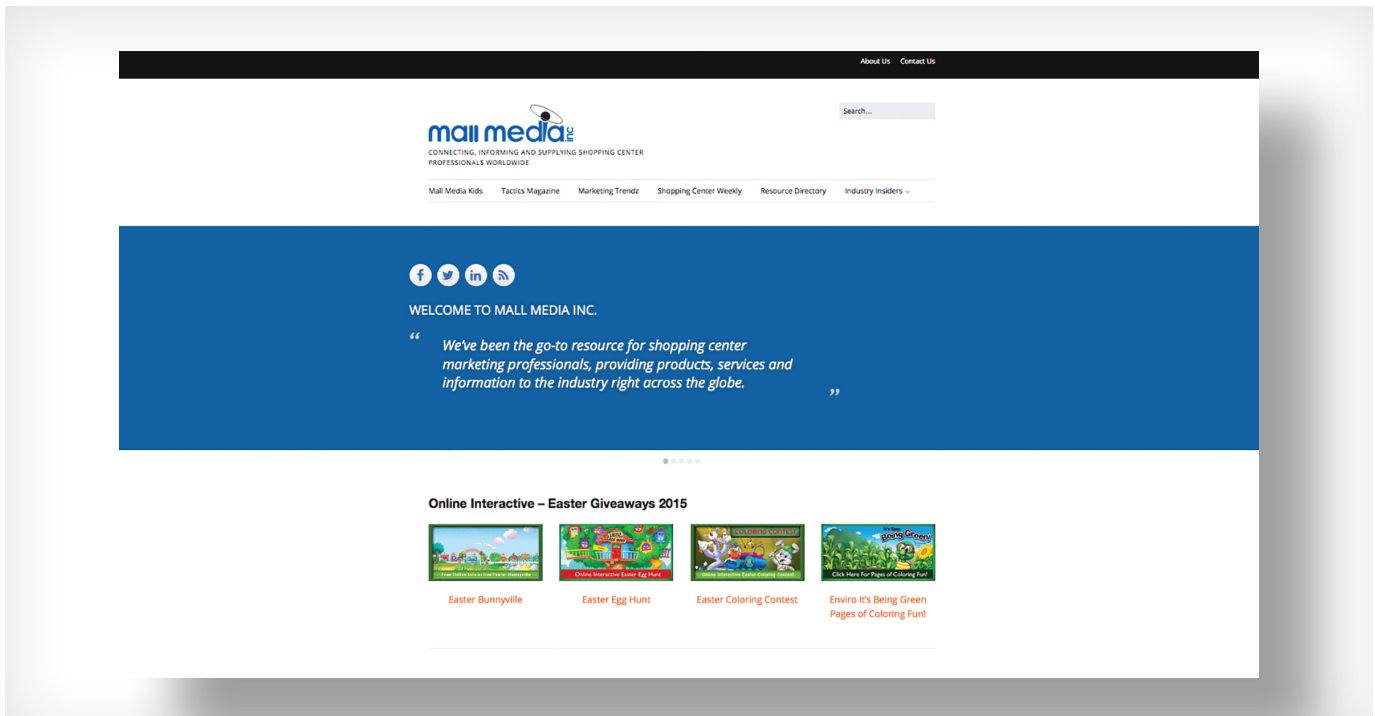



# Are You an Industry Insider

With any booking of a banner ad on the Tactics Online website homepage or a full-page display ad in one of the quarterly special print editions of *Tactics Magazine*, you will receive the opportunity to place your own advertorial profile page on the Mall Media Hub for free.

Advertorials offer an ideal platform for you to (re)introduce yourself as an industry insider to the shopping center industry worldwide, while giving general managers and marketers the additional information they need to begin the process of outsourcing key aspects of their strategic planning.

Advertorials make the most of the interactive nature of the Web, with links to your company's website, e-mail addresses, multimedia content and social media pages. They also relate to the broad topics that we will focus on in each special print edition of *Tactics*, and act as extensions of our annual Shopping Center Resource Directory, which incidentally is now accessible year-round and is fully searchable on our Tactics Online news website.

In addition to the advertorial offer, *Tactics* advertisers will also receive promotional space of equal dollar value to their magazine booking on our *Shopping Center Weekly* e-newsletter. *Shopping Center Weekly* is distributed to virtually every major mall in Canada, the USA, Australia, and Europe. Our monthly circulation is 29,200 (7,300 per week).

---

To view our most recently posted advertorial profiles, simply visit [www.MallMedia.net](http://www.MallMedia.net).



For ad rates, contact Marianne Svensson at [marianne@tacticsmagazine.com](mailto:marianne@tacticsmagazine.com).



For editorial guidelines, contact Myriam Beaugé at [myriamb@mallmedia.net](mailto:myriamb@mallmedia.net).



**tactics**

www.tacticsmagazine.com

## TACTICS MAGAZINE

The Global News Source for Shopping Center Professionals

7,300 WEEKLY SUBSCRIBERS • 29,200 READERS EVERY MONTH

Recognized since 25 years as the industry's leading trade publication with a strong marketing focus, *Tactics* has expanded its content to share strategies relating to other aspects of shopping center business, including leasing, center management and maintenance, property development, retail store operation and promotion, professional development, and more. That's in addition to continued coverage of advertising campaigns, seasonal programs, sales promotions and events, technology-based initiatives, and other marketing strategies.

### **Tactics Magazine – Website, Print Edition and App**

*Tactics Magazine* recently launched online to deliver daily news posts and weekly articles on its new Web platform. It also offers a free app for iOS and Android devices, and prints quarterly special editions focused on Visual Merchandising, Holiday Programs, Retail Technology, and Shopping Center Business.

The magazine is designed to assist professionals who are responsible for marketing and managing shopping malls, open-air centers, lifestyle and town centers, outlet centers, and retail parks.

Our readership, which ranges from property-based managers to senior corporate executives, has proven purchasing powers across all areas of shopping center management—creative design, media planning, leasing, market research, décor, sales promotion and events, digital marketing, operations, maintenance, sustainability upgrades, and customer service.

If you are serious about targeting this very lucrative pool of decision makers, advertising in the online and print editions of *Tactics Magazine* is your best option. Click [here](#) to take a video tour of *Tactics*.



**We are now on Twitter. Follow us on [Twitter.com/TacticsMag](https://twitter.com/TacticsMag).**

**Advertising Email Contact: Marianne Svensson, [marianne@tacticsmagazine.com](mailto:marianne@tacticsmagazine.com)**

## EDITORIAL CALENDAR



**Tactics Magazine** provides you with some comprehensive advertising solutions that include topic-focused and premium homepage banner advertising on TacticsMagazine.com, and display advertising placements in its quarterly special print editions. *Tactics Magazine* also offers sustained promotional support to its ad clients on the MallMedia.net hub, *Tactics* app, and via the *Shopping Center Weekly* e-mail newsletter.

Please note that the editorial calendar is subject to change without any advance notice.

EDITORIAL	SPECIAL EDITIONS FOR 2017			
	I	II	III	IV
<ul style="list-style-type: none"> <li>• <b>Annual Special Edition:</b> VISUAL MERCHANDISING</li> <li>• <b>Feature:</b> Mall Traffic Management</li> <li>• <b>Feature:</b> Parking Programs</li> <li>• <b>Editorial &amp; Ad Submission Deadline:</b> FEBRUARY 17, 2017</li> </ul>				
<ul style="list-style-type: none"> <li>• <b>Annual Special Edition:</b> TACTICS HOLIDAY GUIDE</li> <li>• <b>Feature:</b> Theme Décor Programs</li> <li>• <b>Feature:</b> Holiday Services</li> <li>• <b>Editorial &amp; Ad Submission Deadline:</b> MAY 12, 2017</li> </ul>				
<ul style="list-style-type: none"> <li>• <b>Annual Special Edition:</b> TACTICS TECHNOLOGY GUIDE</li> <li>• <b>Feature:</b> Location-based Promotions &amp; Services</li> <li>• <b>Feature:</b> Tech-based Entertainment</li> <li>• <b>Easter &amp; Spring Preview</b></li> <li>• <b>Editorial &amp; Ad Submission Deadline:</b> AUGUST 18, 2017</li> </ul>				
<ul style="list-style-type: none"> <li>• <b>Annual Special Edition:</b> SHOPPING CENTER BUSINESS</li> <li>• <b>Feature:</b> 2018 Shopping Center Resource Directory</li> <li>• <b>Feature:</b> Sustainability Initiatives</li> <li>• <b>Feature:</b> Children’s Play Areas &amp; Programs</li> <li>• <b>Editorial &amp; Ad Submission Deadline:</b> NOVEMBER 9, 2017</li> </ul>				

## PRINT AD MECHANICAL SPECIFICATIONS

**WORLDWIDE**  
(except Australia & United Kingdom)

 \* with 0.125 inches bleed around the page ad  
 actual page ad dimension with out bleed

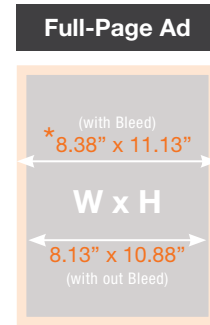
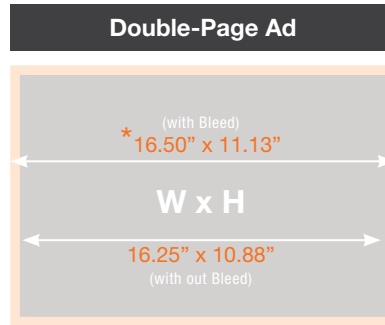

### Bleed Not Required

**Legends:**

-  - Ad Size
-  - Page area

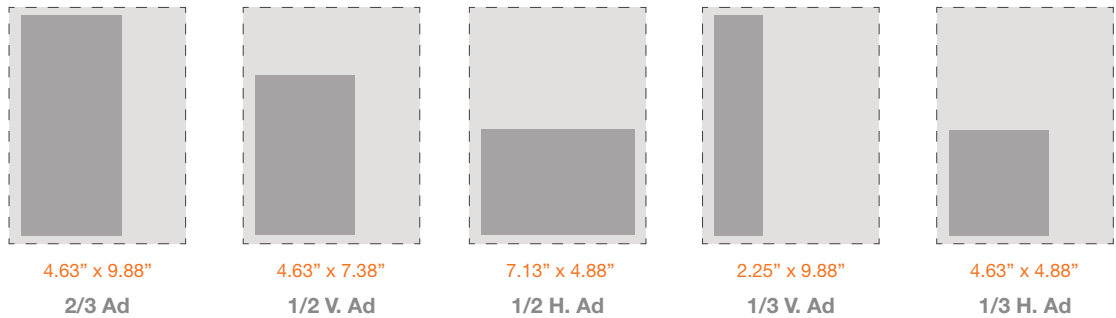

\$ - US Dollar

Four Colour Process	1X	2X	4X
<b>Double</b>	\$3,500	\$3,250	\$3,000
<b>Full</b>	\$2,000	\$1,750	\$1,500
<b>2/3</b>	\$1,600	\$1,300	\$1,000
<b>1/2</b>	\$1,200	\$1,000	\$800
<b>1/3</b>	\$700	\$600	\$500

Covers (4/C only)	1X	2X	4X
<b>Inside</b> (front or back)	\$2,250	\$2,000	\$1,750
<b>Outside</b> (back cover)*	\$2,500	\$2,250	\$2,000

(\*)\*: All outside back cover placements come with a top banner ad placement for two (2) months on the TacticsMagazine.com website.



**Please note that covers are non-cancelable.**

### Bonus:

Whatever you spend on advertising in *Tactics* online or in print will act as a credit toward advertising in *SCW*.

## PRINT AD MECHANICAL SPECIFICATIONS

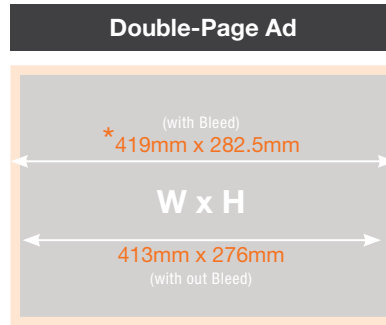

### AUSTRALIA & UNITED KINGDOM

 \* with 3.175 mm bleed around the page ad  
 actual page ad dimension with out bleed



### Bleed Not Required

#### Legends:

 - Ad Size  
 - Page area

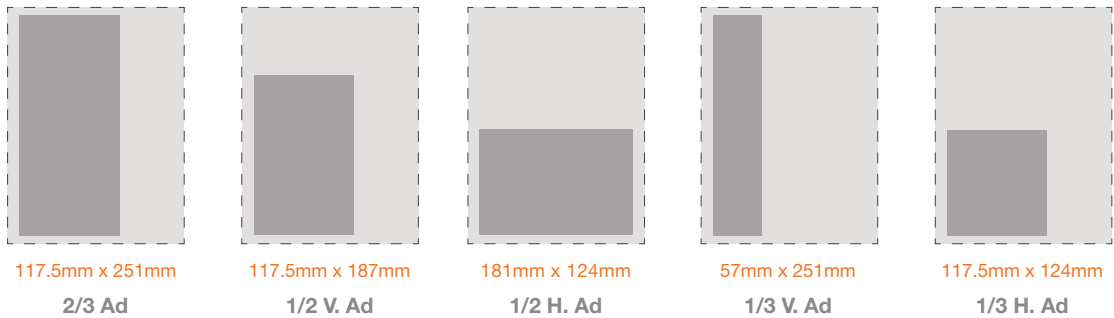

\$ - Australian Dollar / £ - British Pound

Four Colour Process	1X	2X	4X
<b>Double</b>	\$3,500	\$3,250	\$3,000
	£2,000	£1,900	£1,800
<b>Full</b>	\$2,000	\$1,750	\$1,500
	£1,200	£1,100	£1,000
<b>2/3</b>	\$1,600	\$1,300	\$1,000
	£1,000	£900	£800
<b>1/2</b>	\$1,200	\$1,000	\$800
	£800	£700	£600
<b>1/3</b>	\$700	\$600	\$500
	£500	£450	£400

\$ - Australian Dollar / £ - British Pound

Covers (4/C only)	1X	2X	4X
<b>Inside</b> (front or back)	\$2,250	\$2,000	\$1,750
	£1,300	£1,200	£1,100
<b>Outside</b> (back cover)*	\$2,500	\$2,250	\$2,000
	£1,500	£1,400	£1,300

(\*)\*: All outside back cover placements come with a top banner ad placement for two (2) months on the TacticsMagazine.com website.

**Please note that covers are non-cancelable.**

#### Bonus:

Whatever you spend on advertising in *Tactics* online or in print will act as a credit toward advertising in *SCW*.

ONLINE NEWSLETTER

# SHOPPING CENTER WEEKLY

Reach the 7,300 shopping center and retail decision makers in North America, Europe, Australia and Asia who have subscribed to receive our e-mail newsletter every week. Place your copy with logo and photo, as well as a direct link to your website.

PLACEMENTS	RATES		NOTE
	\$	£ - UK Only	
<p>Four consecutive ad placements</p> <p>Actual ad size - 184px by 184px @ 72dpi Format: JPG or PNG (maximum file size: 100kb)</p>	\$400.00	£300.00	To maintain the quality of the ad when viewed on different platforms, please send to us in <b>440px by 440px</b> size.
<p>One ad placement per month</p> <p>Actual ad size - 184px by 184px @ 72dpi Format: JPG or PNG (maximum file size: 100kb)</p>	\$200	£150	
<p>Premium banner placement in all three editions of Shopping Center Weekly</p> <p>Actual ad size - 600px by 200px @ 72dpi Format: JPG or PNG (maximum file size: 100kb)</p>	\$200.00/wk or \$600.00/m	£150.00/wk or £450.00/m	Please note that these premium placement deals cannot be combined with any other promotional offer.  The <i>Tactics</i> bonus credit does not apply.

**Bonus:** Whatever you spend on advertising in *SCW* will act as a credit toward advertising in *Tactics Magazine* online or in print.

## TACTICS ONLINE AD (SPECIFICATIONS)

All prices shown are for a one-month placement ( 4 Insertions ). Prices are quoted in U.S. dollars.

<p><b>Homepage Banner Ad</b> Only one (1) spot available.</p>	<p>\$1,000.00 728px by 90px</p>
<p><b>Homepage Skyscraper Ad</b> Four (4) spots available.</p>	<p>\$500.00 180px by 150px</p>
<p><b>Department Skyscraper</b> Several categories and spots available.</p>	<p>\$300.00 340px by 72px</p>
<p><b>Sponsored Features</b></p>	<p>\$1,500.00</p>

### SPONSORED FEATURES

Each issue of *Tactics Magazine* gives you the opportunity to communicate with your target market in your own words.

Sponsored features provide you with a vehicle to engage marketing managers and center managers, using your own editorial, pictures and graphics to present your business from your own perspective.

Sponsored features can tell your company's story and support your display advertising strategy to help you grow your business.

Please email us at [marianne@tacticsmagazine.com](mailto:marianne@tacticsmagazine.com) for details.

Please contact us for details on ad packages.



## INSERTS & FLYERS (North America only)

Your pre-printed advertising flyers can be distributed inside or outside the magazine. Please note that inserts **must be trimmed** no larger than 8"x10".

**Full distribution coverage** | 35¢ per piece • **Partial distribution coverage** | 40¢ per piece

**In-house production and design support available.**

## MATERIAL REQUIREMENTS

Electronic files must include all fonts and support files. Mac format preferred (Adobe Creative Cloud). We recommend delivering your files in PDF format. If using PDF files, please be sure to embed all fonts and images.

## TERMS AND CONDITIONS

1	All rates subject to applicable taxes.
2	Advertisers who do not fulfill contracts will be charged the "short rate," which is the difference between the next higher insertion rate and the frequency discounted rate.
3	Frequency discount rates will only be in effect if all insertions are run within one (1) year of an agreement being set up.
4	Advertising subject to approval. We reserve the right to revise or reject advertisements in accordance with standards acceptable to Mall Media Inc.
5	An order not corresponding to the current rate card will be regarded as an error and advertising will be billed with rates in force.
6	When revised ads or copy are not received by material deadline, copy run in previous issue will be inserted.
7	No space cancellations will be accepted after closing dates. Covers are non-cancelable.
8	Publisher limits his liability for errors in printed advertisements to 10% of the space value of the ad.
9	Publisher will make every attempt to provide a proof; otherwise reserves the right to run an ad prepared from rough draft material.
10	Please make cheque payable to: Mall Media Inc.
11	<b>Please send payment to either:</b> 4416 Dawson Street, Burnaby, BC, Canada V5C 4B9 or PMB 4416, 250 H Street, Blaine, WA 98230



[www.MarketinTrendz.net](http://www.MarketinTrendz.net)

*Marketing Trendz* is the leading global professional how-to guide for shopping center and general retail marketing.

This contemporary full-color magazine, which comes in print and enhanced digital formats, offers in-depth advertising campaign cover stories, how-to marketing tips, consumer research, demographic trends, retail product news, and Web-based marketing strategies.

Our readership ranges from shopping center property managers to senior executives at development companies. If you're keen to reach them, then advertising in *Marketing Trendz* is an opportunity not to be missed.

## Your Vehicle, your decision

**Marketing Trendz** doesn't merely offer promotional space in its editions, but it also provides a comprehensive advertising package that includes the placement of advertising features. *Marketing Trendz* also offers sustained advertising and promotional support to its clients online on MarketingTrendz.net and via the *Shopping Center Weekly* e-mail newsletter.

## TRENDZ CONTENTS SAMPLE

### Cover Story | ADVERTISING CAMPAIGN

#### Departments:

- Community Relations
- Digital Marketing/Social Media
- Mall Giveaways
- Product News
- Leasing Programs
- Retail Trends
- Sales Promotion & Events
- Webmasters
- And more...

## EDITORIAL & AD SUBMISSION DEADLINES

**Editorial:** Myriam Beaugé, myriamb@marketingtrendz.net.

**Advertising:** Marianne Svensson, marianne@tacticsmagazine.com.

**Please note that the magazine contents are subject to change without advance notice.**

**PRINT AD  
MECHANICAL SPECIFICATIONS**

Trendz Magazine



**INSIDE & OUTSIDE BACK COVER AD**

Four Colour Process	Back Cover	1x	3x	6x	12x
US rates	INSIDE	\$1,185	\$1,025	\$900	\$800
	OUTSIDE *	\$1,750	\$1,500	\$1,200	\$1,000
Australia rates	INSIDE	\$1,185	\$1,025	\$900	\$800
	OUTSIDE *	\$1,750	\$1,500	\$1,200	\$1,000
United Kingdom rates	INSIDE	£890	£770	£675	£600
	OUTSIDE *	£1,200	£1,100	£1,050	£1,000

(\*): All outside back cover placements come with a top banner ad placement for one (1) month on the MarketingTrendz.net website.

**Please note that outside and inside back covers are non-cancelable.**



Shopping  
Center  
Weekly



**DELIVERED**  
FROM  
**THE DIGITAL PRESSES**  
**EVERY** THURSDAY

For the latest news in mall marketing, sign up for free at:  
**WWW.TACTICSMAGAZINE.COM**



[Facebook.com/shoppingcenterweekly](https://www.facebook.com/shoppingcenterweekly)

## Key Contacts

### Publishing

**Brian Lehn**

Publisher | [brianl@mallmedia.net](mailto:brianl@mallmedia.net)

### Editorial

**Myriam Beaugé**

Editor-in-Chief | [myriamb@mallmedia.net](mailto:myriamb@mallmedia.net)

### Advertising

**Marianne Svensson**

Global Client Services | [marianne@tacticsmagazine.com](mailto:marianne@tacticsmagazine.com)

### Shopping Center Weekly

**Myriam Beaugé**

Online Editor | [myriamb@mallmedia.net](mailto:myriamb@mallmedia.net)

### Graphic Design & Production

**Christina Lehn**

Art Director | [christina@mallmedia.net](mailto:christina@mallmedia.net)

### Multimedia

**Scott Balfour**

Multimedia Manager | [scott@mallmedia.net](mailto:scott@mallmedia.net)

### Subscriptions

**Marianne Svensson**

Global Client Services | [marianne@tacticsmagazine.com](mailto:marianne@tacticsmagazine.com)

Follow us on:



### Our Offices

#### Head Office

4416 Dawson Street  
Burnaby, BC Canada V5C 4B9

[www.MallMedia.net](http://www.MallMedia.net)

#### TOLL FREE IN NORTH AMERICA

Phone: 1.800.665.2115

Fax: 1.604.294.9421

#### TOLL FREE IN THE UNITED KINGDOM

Phone: 0800.404.9413

Fax: 0800.404.9414

#### TOLL FREE IN AUSTRALIA

Phone: 1.800.005.583

Fax: 1.800.005.589

#### WORLDWIDE

Phone: 001.604.294.6671

Fax: 001.604.294.9421